

User manual for:

Manufacturer	Model
Interlevin	PD110T
	PD220T

Uploaded: October 2016

Interlevin Refrigeration Ltd
West Meadow Rise
Castle Donington
Derby
DE74 2HL

Sales: 01332 850090
Parts: 01332 850190
Service: 01332 850064
Email: trade.sales@interlevin.co.uk
Web: www.interlevin.co.uk

INSTRUCTION MANUAL

DISPLAY COOLERS



PD110T

PD220T

Thank you for choosing this appliance. It is essential that you read these instructions carefully and keep the booklet in a safe place for your future reference. The booklet contains mandatory safety information as well as essential maintenance routines. Failure to observe the instructions is unsafe and will also invalidate the guarantee.



WARNING!

Any refrigeration repair or any electrical work must only be carried out by suitably qualified and competent persons.



TABLE OF CONTENTS

1.0	SAFETY AND INSTALLATION	
1.1	Safety Information.....	3-4
1.2	Unpacking and positioning (before connecting to the power supply)...	4-5
1.3	Connecting the cooler to the Power Supply.....	6
2.0	OPERATION	
2.1	Operation of the Appliance.....	6
2.2	Adjustment of the temperature.....	6
3.0	MAINTENANCE	
3.1	Lighting.....	7
3.2	Cleaning the interior and exterior.....	7
3.3	Cleaning the Condenser.....	7
4.0	IN THE EVENT OF A MALFUNCTION.....	8
5.0	DISPOSAL AT END-OF-LIFE.....	8
6.0	CONTACTS.....	8

The information within this booklet was correct at the time of printing.
Specifications and information may alter without notice.

1.0 SAFETY AND INSTALLATION

1.1 Safety Information

	<p>WARNING!</p> <p>All electrical work must be carried out by suitably qualified persons</p>	 <small>Caution! Risk of Fire</small>	
---	---	---	---

Warning! Please observe the following safety precautions and instructions at all times:

- This appliance is for indoor use only.
- Do not use this appliance other than for its intended use as a beverage display cooler.
- Always disconnect the mains power supply before removing any covers, performing maintenance work, cleaning or making any repairs.
- This appliance can be used by children aged from 8 years and above and persons with reduced physical, sensory or mental capabilities or lack of knowledge if they have been given supervision or instruction concerning the use of the appliance in a safe way and understand the hazards involved. Children shall not play with the appliance. Cleaning and user maintenance shall not be made by children without supervision.
- Do not cover the front grille or rear air vents and please observe the installation and setting up instructions described later in this manual. Adequate ventilation must be ensured for the appliance. Keep clear of obstruction all ventilation openings in the appliance enclosure .
- Do not probe any openings in the cabinet and be careful not to touch any moving parts such as the fans, or hot surfaces such as the compressor, or rear pipework; or cold surfaces such as the interior surfaces or the evaporator plate.
- Any electrical work on the cabinet should only be carried out by suitably qualified, competent and skilled persons.
- Do not overload the power supply. Always ensure that the power supply is sufficient for the electrical requirements specified on the rating label. The rating label is located inside the cabinet on the side wall. If in doubt, please consult a qualified electrician. Important: Never use adaptors or multi-block extension leads to connect the appliance to the mains power.
- If the mains power supply cord is damaged, it must be replaced by the appliance manufacturer, its service agent or suitably qualified, competent and skilled persons in order to avoid a hazard. A skilled person is somebody who possesses the appropriate technical training, experience and valid certifications necessary to be aware of the hazards to which he or she may be exposed and of the measures necessary to minimise the dangers to themselves and other persons. A competent person is defined as someone who has acquired the knowledge and skills to carry out the task, through training, qualification or experience. They must also have had the appropriate training or practical experience (or both) in the subject sufficient to provide safe and satisfactory performance.

- Do not store explosive substances such as aerosol cans with a flammable propellant inside this appliance.
- Do not use any electrical appliances inside the refrigerated compartment of this appliance.
- Do not use any mechanical devices or other means to accelerate the defrosting process. Defrosting is performed automatically by the electronic controller and needs no user intervention.
- Do not damage the refrigeration circuit. If you do so, then open a window or door immediately so as to ventilate the area. The refrigerant is flammable.
- This appliance contains flammable refrigerant within its sealed system and also within the insulation foam. As such it is mandatory that the cabinet is serviced and, at end-of-life, recycled by a professional organisation and skilled persons who have the necessary qualifications, certifications and expertise to do so. If in doubt please consult your Local Authority or contact us.
- The appliance uses LED lighting. The lighting strips and transformer should only be replaced using genuine parts of the same technical specification.
- During all operations, please be careful not to jolt, jar, bump or thump the cabinet. Handle it gently and with care. The refrigeration pipework is delicate and will be damaged by rough handling.
- Do not exceed the maximum shelf loading weight of 25 kgs per shelf so as to avoid injury or damage.
- Never move or tilt the appliance whilst the power switch is in the “ON” position.
- The appliance must always be earthed.
- The appliance must only be charged with R600a refrigerant from an authorised supplier. To use another type of refrigerant would be dangerous and is not permitted under any circumstances.
- Electrical equipment should not be placed under the unit or where refrigerant could gather in the event of a leak.
- If it is necessary to repair the refrigeration such that it needs to be opened or charged, then it will be necessary for the technician to possess a Gas Work Authorisation (hydrocarbon refrigerants). Queensland, Australia has particular regulations for such activities.
- The electrical wiring diagram is to be found on the appliance itself and is located inside the cabinet on the side wall.

1.2 Unpacking and positioning (before connecting to the power supply)

- During all operations, please be careful not to jolt, jar, bump or thump the cabinet. Handle it gently and with care. The refrigeration pipework is delicate and will be damaged by rough handling.
- The appliance is heavy and therefore please carry out a risk assessment prior to beginning this operation.
- Please cut the banding straps taking the necessary precautions to avoid hurting yourself or others. Remove all of the packaging and ensure that it is recycled in

accordance with all local laws and regulations. Safety Note: Please pay special attention to the hazard represented by the plastic bag so that it may not be taken by children.

- Please take care not to pinch or damage the power cord in any way. Please examine the power cord for any splits, cuts or damage.
- The shelves may be adjusted by moving the clips as illustrated in Figure 1 below:

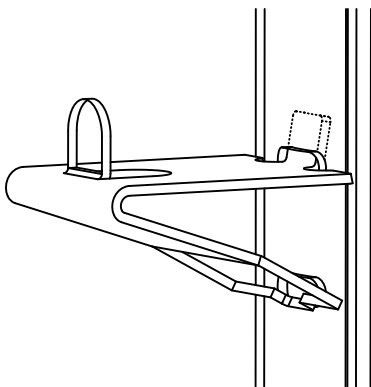

Figure 1

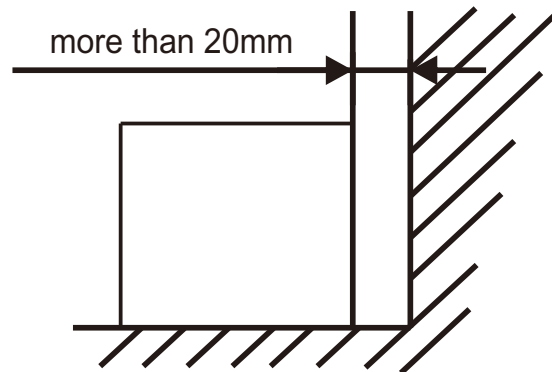

Figure 2

- Warning: Do not exceed the maximum shelf loading weight of 25 kgs per shelf so as to avoid injury or damage. Please ensure that the shelf support clips are securely located in to the support strip for safe operations. The shelves may be adjusted by squeezing together the relevant support clips and re-locating in a new position. Please ensure the clips are fully inserted and securely located prior to loading the shelves. The clips should be mounted in such a way that the shelf is level. Failure to do so could result in the shelf falling out of position and would be dangerous.
- This appliance is designed for a maximum of Climate Class 4. Please refer to the rating plate. Climate Class 4 is defined as a maximum environmental condition of 30C ambient temperature and 55% relative humidity.
- Do not place it next to a source of heat or humidity such as a glass or dish washer, heater outlet, oven or any other potential heat or humidity emitting appliance or structure.
- Do not place the appliance in direct sunlight.
- Do not place near to a source of static electricity or where it is vulnerable to lightning strike.
- The room must be well ventilated and free from sources of ignition. It must not be located in a position where refrigerant could gather in the event of a leak. If it is below ground level then extra precautions may be necessary and an expert should be consulted. In Australia and New Zealand, the provisions of AS1677:2 1998 and subsequent amendments must be adhered to.
- Please make sure the floor is level and even. If the cabinet is not level, hazards and malfunctions may occur including, but not limited to, the condensate water not draining away and the doors not functioning correctly. You may adjust the appliance using the levelling feet, being careful not to pinch your fingers.
- The appliance requires a minimum ventilation space at sides top and rear of 20mm. The front grille must be completely unobstructed. See Figure 2.

1.3 Connecting the cooler to the Power Supply

- Please observe all of the warnings and procedures stated in section 1.1.
- Please take care not to pinch or damage the power cord in any way. Please examine the power cord for any splits, cuts or damage. If it is unsatisfactory then it must be replaced according to the instructions stated in 1.1.
- Plug in the cooler and turn on the power.
- Switch on the appliance using the red power switch on the front control panel.

2.0 OPERATION

2.1 Operation of the Appliance

- The appliance is designed to run automatically. Defrosting is automatic. The condensate water is evaporated automatically by the system.
- Maintenance must be performed according to the procedures detailed in section 3 of these instructions.

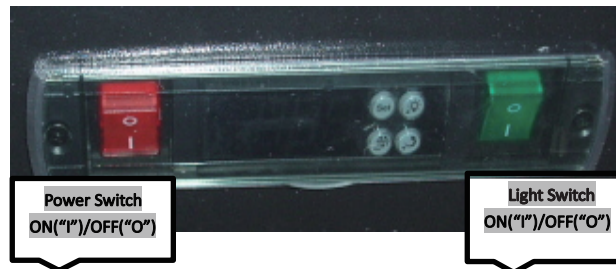



2.2 Adjustment of the temperature

- The electronic controller has been factory set to chill the beverages to approximately 2 Centigrade. Should you wish to alter the set point, please adopt the following procedure;

Front panel:



- SET Press and hold for 3 seconds to enter the menu.
-  (DEF) To activate a manual defrost, press this button.
-  (UP) Increases the parameter value.
-  (DOWN) Decreases the parameter value.

Step 1: Press and hold the "SET" button for approximately 3 seconds until the display flashes "st"

Step 2: Press the set button quickly once more and the current set point temperature will be displayed.

Step 3: Press the up or down buttons to adjust the setting temperature.

Step 4: Press and hold the SET button for approximately 3 seconds and your new selection will be stored. If you fail to press SET, the controller will time out and revert to the previously stored setting.

3.0 MAINTENANCE

Please observe all of the safety warnings, precautions and instructions set out in Section 1.

3.1 Lighting

- The appliance uses LED lighting strips powered by a low voltage transformer. If replacement is required, please order genuine replacement parts from us. Replacement is a job for an appropriately qualified, skilled and competent person.

3.2 Cleaning the interior and exterior

- The interior walls and shelves should be cleaned and sanitised on a regular basis so as to ensure hygiene regulations are met. Please do not use splashing, dripping, jetting or running water. Do not use steam. Only a damp or wet cloth should be used in conjunction with appropriate cleaning materials for the task in hand. Always follow the instructions specific to the cleaning materials being used.

3.3 Cleaning the Condenser

- The condenser is located at the front of the appliance behind the compressor compartment cover. The function of the condenser is to dissipate the heat that has been extracted from the interior of the cabinet. In order for it to work efficiently (or at all), it must be kept clean and free of dust at all times.
- This appliance has a low maintenance condenser that is less prone to blockage than other types. However it is still recommended to check that it is clean and dust free at least every three months.

Step 1: Empty the appliance. Switch it off using the red power switch. Pull it out from its enclosure. Unplug from the mains power supply.

Step 2: Looking at the front of the appliance, remove the screws from the front compartment cover.

Step 3: Locate the condenser and examine it for dust or debris.

Step 4: Clean the condenser using the nozzle of a vacuum cleaner or a soft brush. Dust that is removed must be cleared away. The condenser is a delicate component and must be treated with great care and respect. Be careful of the fan blades and be sure not to bend or deflect them in any way. NEVER use water in this area.

Note: If the condenser has been contaminated with grease or fat, then a skilled and competent refrigeration specialist will be required to do the cleaning. Do not use the cabinet or plug it back in until the cleaning has been done professionally by a skilled person. A fire hazard may be present.

Step 5: Replace the cover and screws and plug back in to the mains power supply.

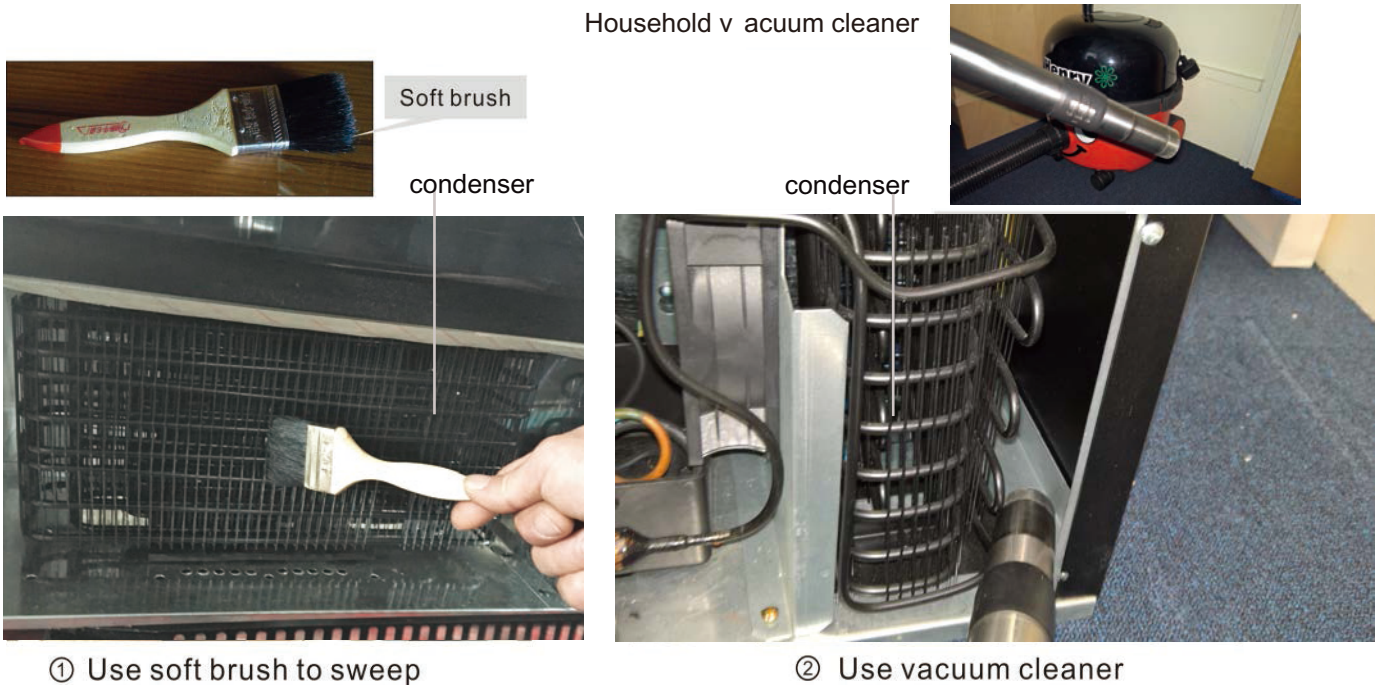

4.0 IN THE EVENT OF A MALFUNCTION

- In the event of a malfunction, please be sure only to use a suitably qualified, competent and skilled refrigeration service engineer and insist upon genuine parts. If the appliance is under guarantee, please call the company from whom you purchased the appliance. Always have the serial number to hand. The serial number is located on the inside wall of the refrigerated compartment. It is often accompanied by, or located next to, a bar code.

5.0 DISPOSAL AT END-OF-LIFE

- This appliance contains flammable refrigerant within its sealed system and also within the insulation foam. It must be recycled by a professional, competent, authorised and regulated organisation with expertise in the handling of refrigeration appliances. For further information, please consult your local Authority.



6.0 CONTACTS

- For further information or to obtain Genuine Spare Parts, please contact:
Interlevin Refrigeration Ltd.
Telephone:01332 850090